



QR code to  
mounting  
video

# Ropox Verti-Inside

User Manual

Mounting Instructions

Service Manual

**Keep this folder with the product at all times!**

# Contents

- 1. INTRODUCTION ..... 3**
- 2. CONFORMITY WITH EU DIRECTIVE AND UK DIRECTIVE..... 3**
- 3. APPLICATION..... 3**
- 4. TECHNICAL DATA ..... 4**
- 5. DIMENSION SKETCH OF VERTI-INSIDE..... 5**
  - 5.1 Construction see dimensions on the following page ..... 5*
  - 5.2 Cupboard sizes..... 6*
  - 5.3 Operation of Verti-Inside ..... 8*
  - 5.4 Wiring diagram ..... 8*
- 6. MOUNTING INSTRUCTIONS ..... 8**
  - 6.1 Mounting of accessories ..... 17*
- 7. PERFORMANCE TEST ..... 18**
- 8. LIST OF COMPONENTS, VERTI-INSIDE ..... 19**
- 9. OPTIONS, VERTI-INSIDE..... 20**
- 10. PLACING OF LED STRIPS. .... 22**
  - FOR VERTI-INSIDE DEBTH 26,5CM ..... 22**
  - FOR VERTI-INSIDE DEBTH 31CM ..... 22**
- 11. CABLES FOR LED SPOT. .... 24**
- 12. SAFETY IN USE..... 25**
- 13. CLEANING/ MAINTENANCE ..... 26**
  - 13.1 Cleaning of frame ..... 26*
  - 13.2 Maintenance ..... 26*
  - 13.3 Service schedule, operation and maintenance ..... 27*
- 14. FAULT FINDING ..... 27**
  - 14.1 The frame cannot be adjusted in height (adjustment is very difficult) ..... 27*
- 15. LABEL..... 28**
- 16. COMPLAINTS ..... 29**

## 1. Introduction

Verti-Inside is a wall cupboard unit for electrical height adjustment of wall cupboards. Verti-Inside is ideal for wheelchair users or persons who are unable to reach the upper shelves of the wall cupboards.



This manual must ALWAYS accompany the product and be read by and available to the user



This appliance is not intended for use by persons (including children) with reduced physical, sensory or mental capabilities, or lack of experience and knowledge, unless they have been given supervision or instruction concerning use of the appliance by a person responsible for their safety. Children should be supervised to ensure that they do not play with the appliance.

The users must follow these instructions. It is very important that the instructions have been read and understood prior to operating the product.

These instructions must always be available to the user and must accompany the product in case of relocation.



**DO NOT** use the system before reading section 12 "Safety in use" & after completing section 7 "Performance test"  
Make sure that **ALL** cables and connections are accessible at any time for maintenance and servicing!!  
This product is electrically height adjustable and the risk of trapping can occur. Operation must always be carried out or supervised by an adult, who has read and understood the importance of Section 12 "Safety in use".

Correct use, operation and inspection are decisive factors for effective and safe performance.

## 2. Conformity with EU Directive and UK Directive

This product has CE marking according to the current Machinery Directive and is therefore in accordance with the basic safety requirements.

This product has UKCA-marking and thus complies with the basic safety requirements.

If these frames are assembled or otherwise combined with other electrical components, the assembly will be considered a new unit, which must be subjected to a risk assessment to obtain CE marking.

## 3. Application

Verti-Inside is designed to obtain optimum working height for the user. Verti-Inside is designed to adjust the height of wall cupboards. Verti-Inside must NOT be used as a lifting unit or person lifter.

The product must be used indoor, under normal room temperature and humidity conditions as stated in Section 4. Verti-Inside is not designed for use in damp rooms.



The control unit has protection IP32/II and must always be installed in accordance with the Danish High Voltage Regulations or corresponding national or international standards.

## 4. Technical data

<b>Product name:</b>	<b>Ropox Verti-Inside</b>
<b>Item numbers:</b>	<b>Item number:</b> White Ral 9010: Verti-Inside width 40cm/15.7in, depth 26.5cm/10.4in: 30-40404 Verti-Inside width 50cm/19.7in, depth 26.5cm/10.4in: 30-40405 Verti-Inside width 60cm/23.6in, depth 26.5cm/10.4in: 30-40406 Verti-Inside width 70cm/27.5in, depth 26.5cm/10.4in: 30-40407 Verti-Inside width 80cm/31.5in, depth 26.5cm/10.4in: 30-40408 Verti-Inside width 90cm/35.4in, depth 26.5cm/10.4in: 30-40409 Verti-Inside width 100cm/39.4in, depth 26.5cm/10.4in: 30-40410  White Ral 9010: Verti-Inside width 40cm/15.7in, depth 31cm/12.2in: 30-40414 Verti-Inside width 50cm/19.7in, depth 31cm/12.2in: 30-40415 Verti-Inside width 60cm/23.6in, depth 31cm/12.2in: 30-40416 Verti-Inside width 70cm/27.5in, depth 31cm/12.2in: 30-40417 Verti-Inside width 80cm/31.5in, depth 31cm/12.2in: 30-40418 Verti-Inside width 90cm/35.4in, depth 31cm/12.2in: 30-40419 Verti-Inside width 100cm/39.4in, depth 31cm/12.2in: 30-40420  Gray Ral 7016: Verti-Inside width 60cm/23.6in, depth 31cm/12.2in: 30-40490 Verti-Inside width 90cm/35.4in, depth 31cm/12.2in: 30-40491 Verti-Inside width 100cm/39.4in, depth 31cm/12.2in: 30-40492
<b>Material:</b>	Welded steel pipes St. 37 and various plastic components
<b>Surface treatment:</b>	Blue chromate, powder coating
<b>Power supply:</b>	220-230V~ / 50-60Hz, 5,0A
<b>Standby primary:</b>	<0.3W
<b>Control voltage:</b>	24VDC
<b>Duty cycle max.:</b>	Max. 2 min. active then 18 min. pause
<b>Max. load:</b>	80kg / 175lb evenly distributed
<b>Speed/time for lifting:</b>	Approx. 33 <sup>mm</sup> / <sub>sec.</sub> – Approx. 15 sec.
<b>Travel</b>	495mm / 19.4in
<b>Temperature:</b>	5-45° C
<b>Air humidity:</b>	5-85% (non-condensing)
<b>Complaints:</b>	See Complaints page 28
<b>Manufacturer:</b>	Ropox A/S, DK-4700 Næstved, Tel.: +45 55 75 05 00 e-mail: info@ropox.dk - www.ropox.dk

## 5. Dimension sketch of Verti-Inside



It is important that cables to the control unit are flexible and can move freely within the height adjustment range of the unit.

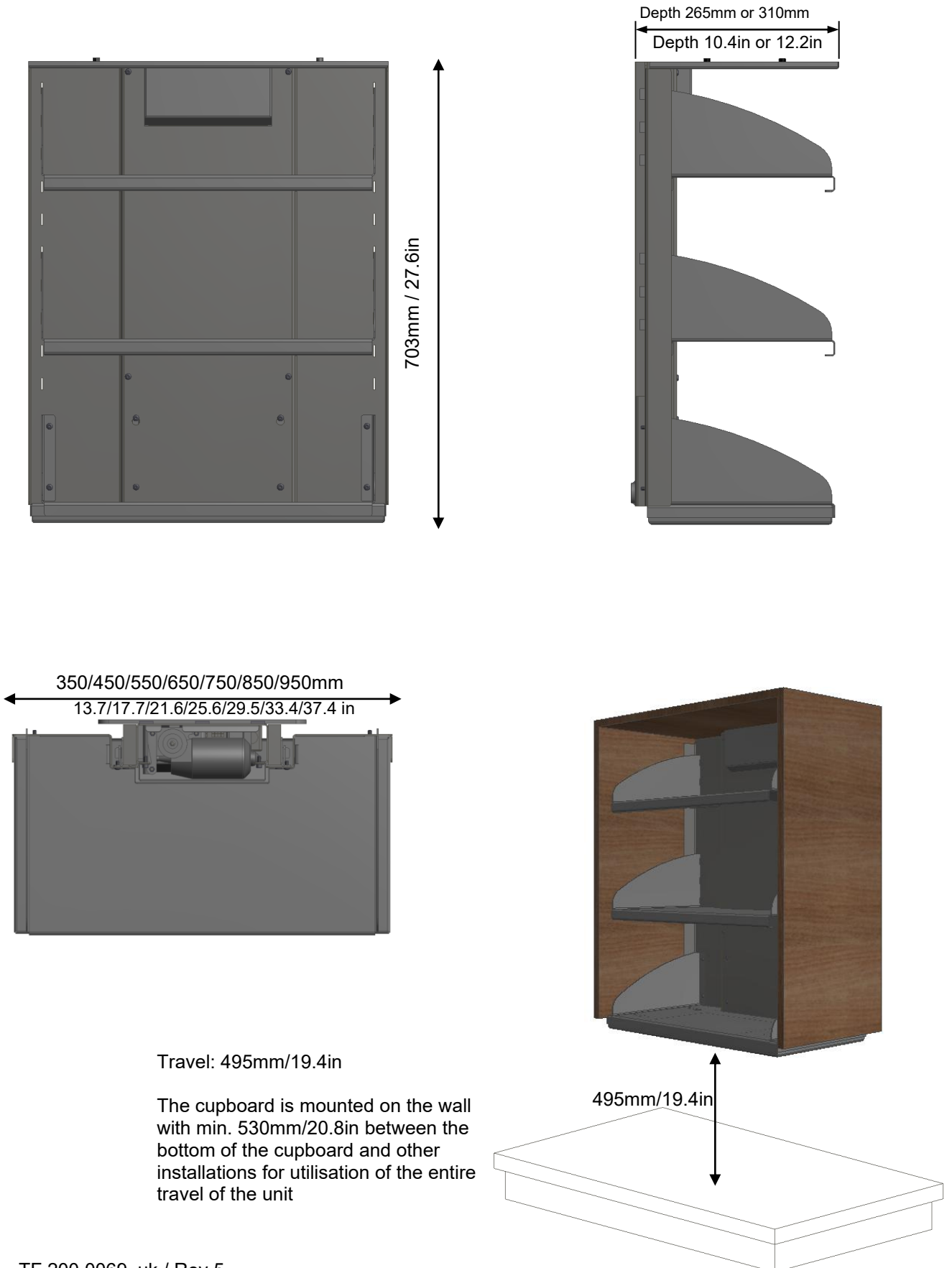

## **5.1 Construction see dimensions on the following page**

 Minimum area for reinforcement of wall. Wall material must be suitable for screw mounting.

 Area for electric installation.

 Area for conduit.

Cabinet height of 70.4cm/27.7in or more. For cabinet heights above 70.4cm/27.7in a fixed shelf is placed in the upper part of the cabinet (see illustration).

Cable for operation must be laid from the cabinet to the front edge of the worktop for mounting of the control switch. We recommend the installation of an empty conduit in the wall to accommodate the cable (ø3.5cm).

If a high cabinet stands in the immediate vicinity of Verti-Inside, the cable may be run through the cabinet to avoid the conduit in the wall.

Max. load 80kg/175lb evenly distributed over all three shelves for cabinets up to 100cm/39.4in in width, according to DS/EN 12182, based on 8 screws/bolts.

### **Minimum load capacity per screw/bolt:**

10.5kg / 23lb

The fitter should always consider the material, condition and strength of the wall and use screws and rawlplugs suitable for the specific wall type.

## **5.2 Cupboard sizes**



Cabinet height of 70.4 cm / 27.7 in

Cabinet height above 70.4 cm / 27.7in

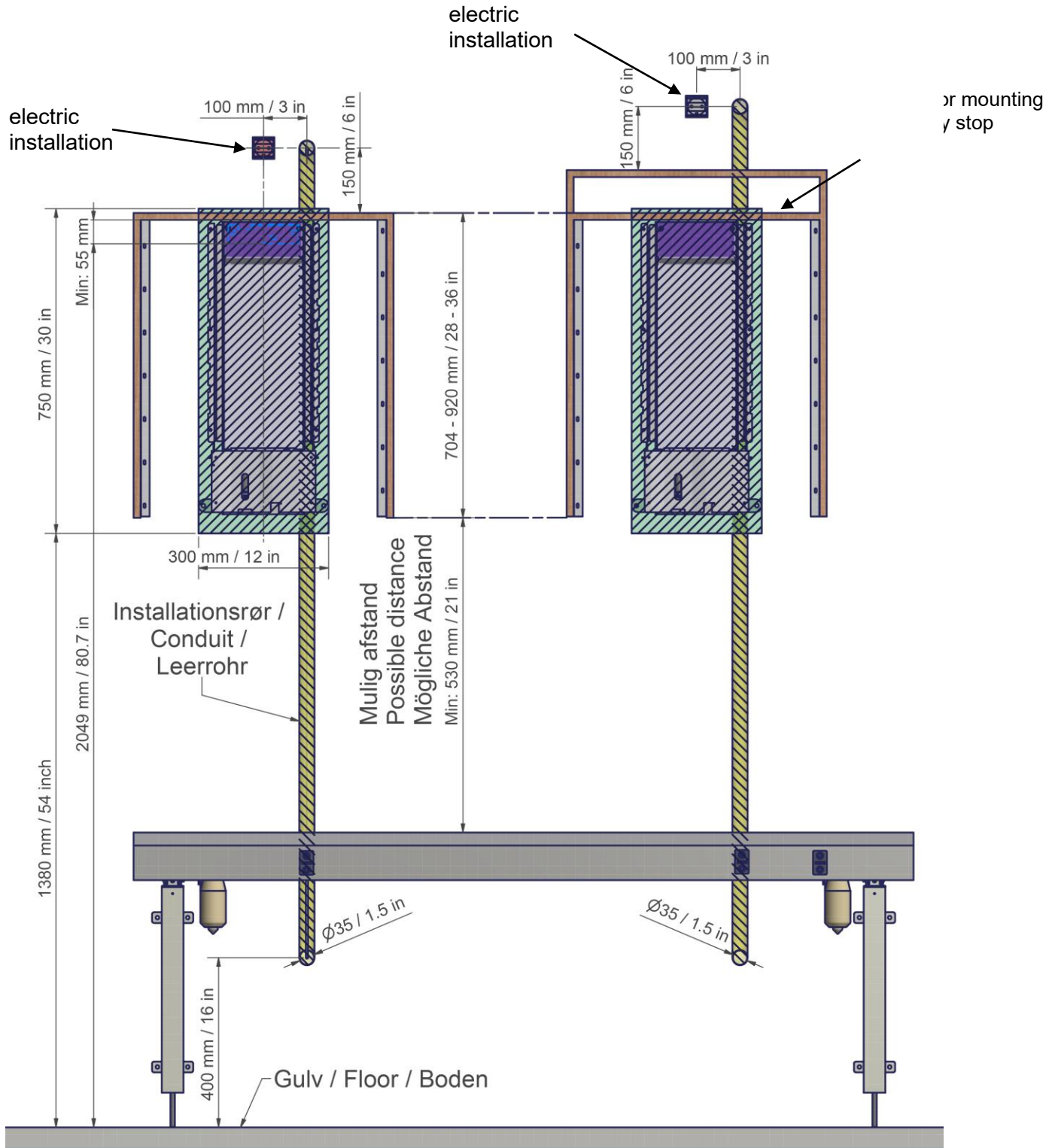

### 5.3 Operation of Verti-Inside

The height of the cupboard is adjusted by means of the control switch connected to the control unit.

The cupboard is adjusted upwards by pressing the UP symbol of the control switch and downwards by pressing the DOWN symbol of the control switch.

As soon as you let go of the control switch, the movement of the unit will stop.



### 5.4 Wiring diagram

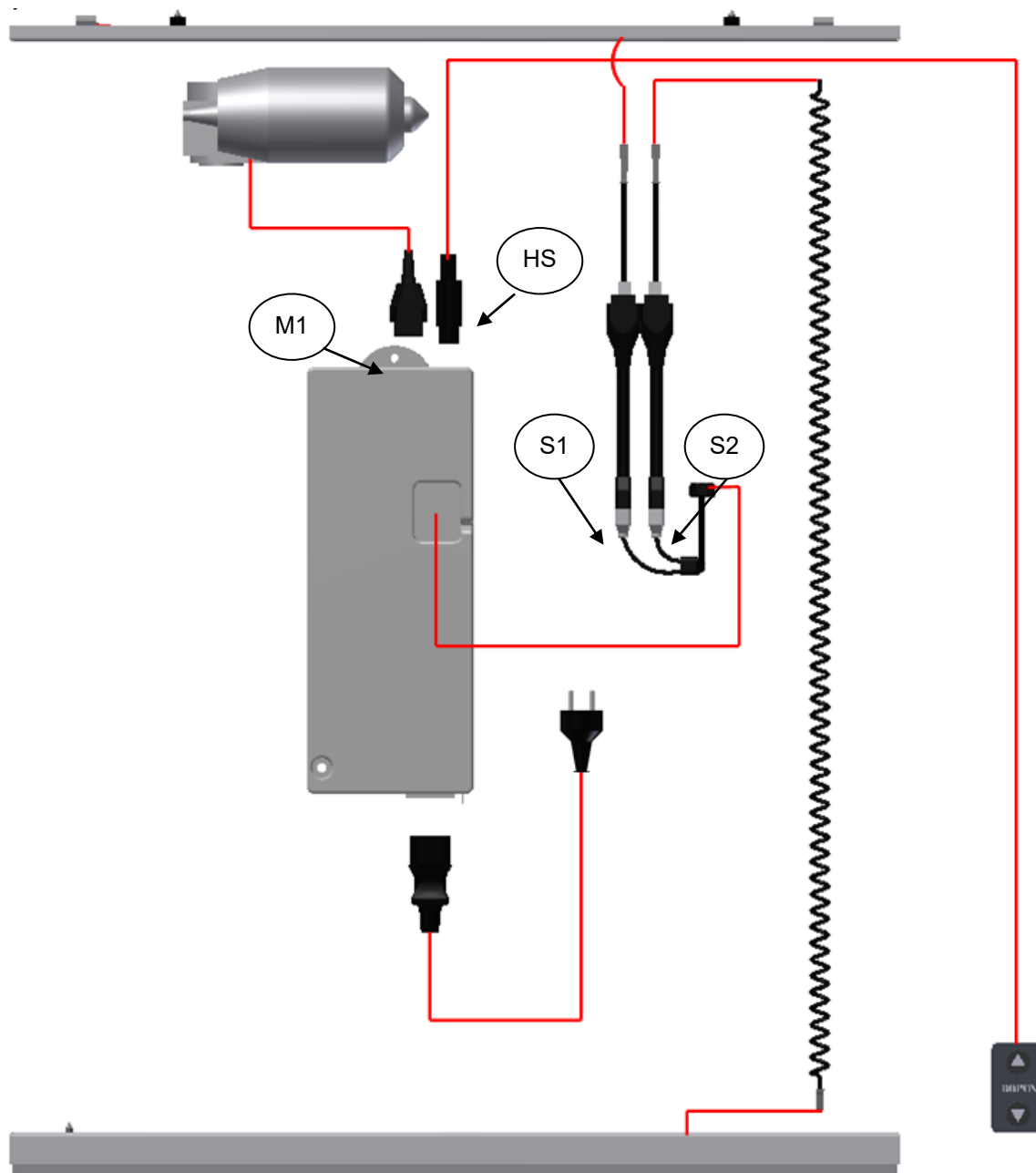

## 6. Mounting instructions



Mounting must always be carried out by competent personnel

Before starting installation, check that all parts mentioned in the list of components have been delivered.

See list of components, Section 8.

1



Remove back and bottom from the cupboard.  
**Note!**  
 The back may remain in place if it is fastened to the wall by bolts

2

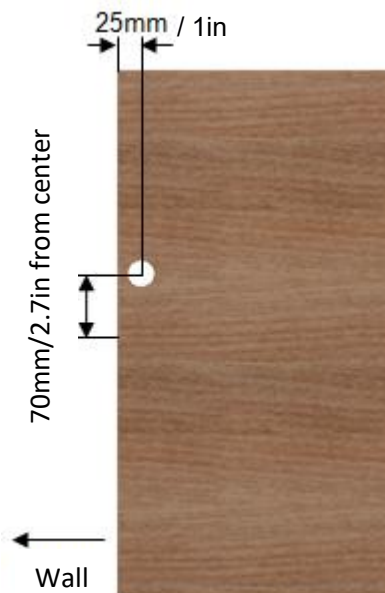

Drill 1 x Ø40mm/1.6in hole in the top of the cupboard for cables

Mark up for upper safety stop (see 9)

3



Mount 2 x 30-40400-021  
 flush with rear edge of cupboard

14 x Ø3.5mm/0.1in x12  
 wood screw



4



Mount cupboard on wall

5

Mount suspension fixture 30-40400-019 on wall

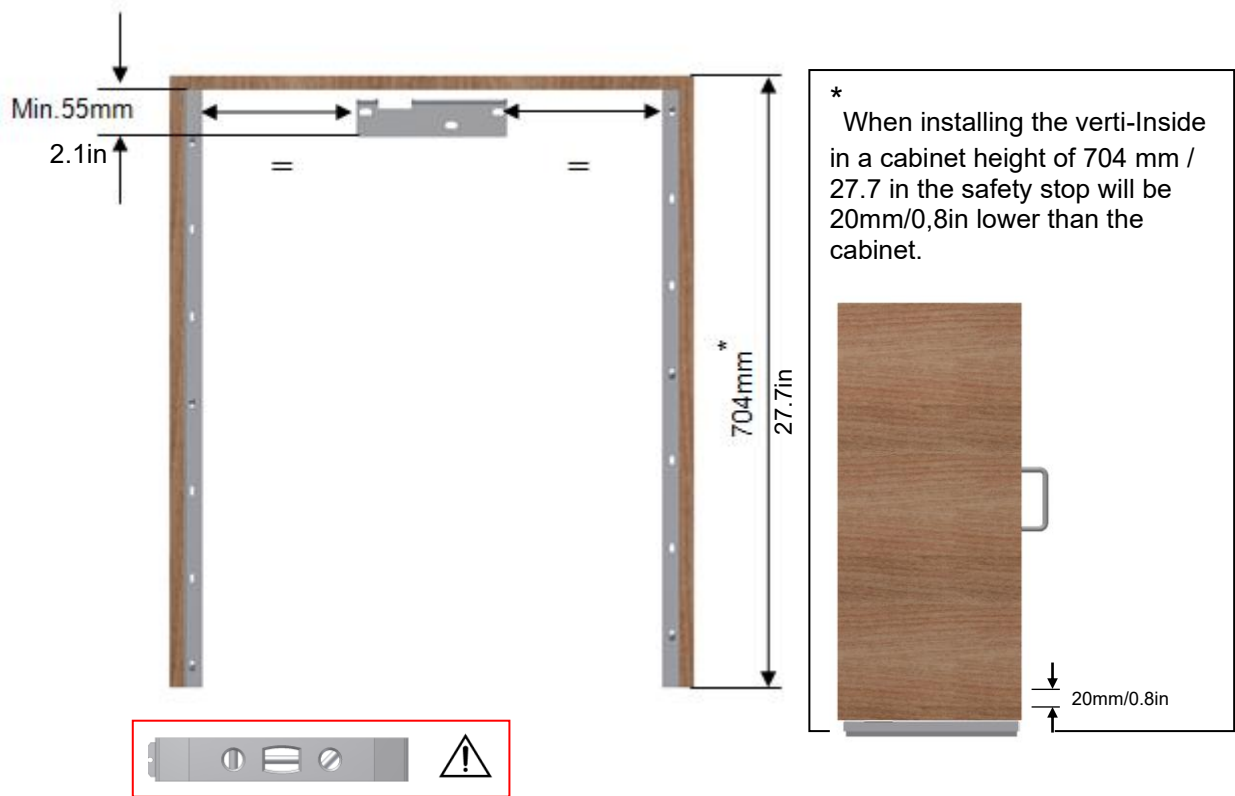

6

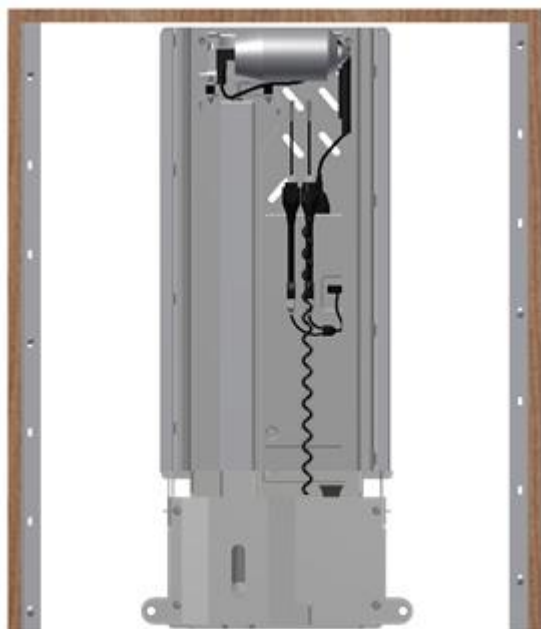

Lift lifting unit 30-40400-042 into the cupboard and hook it onto the suspension fixture

7



Drill holes in wall. Fasten lifting unit 30-40400-042 with 7 screws. Use screws and lplugs suiting the construction and materials of the wall

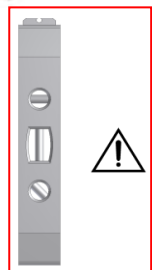

8



1. Connect the control switch to HS  
If required, use extension cord: 93000162  
Pull the cable behind the motor and through the hole at the top of the cupboard
2. Pull mains cable behind the motor and through the hole at the top of the cupboard, connect and turn on power
3. Connect the motor cable 96000814 to M1

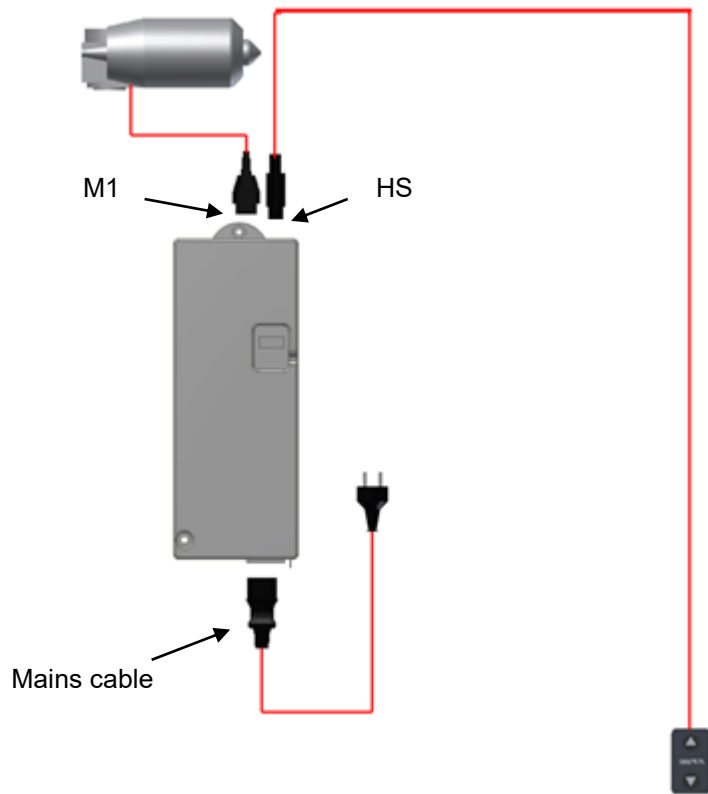

## Monting of top safety stop

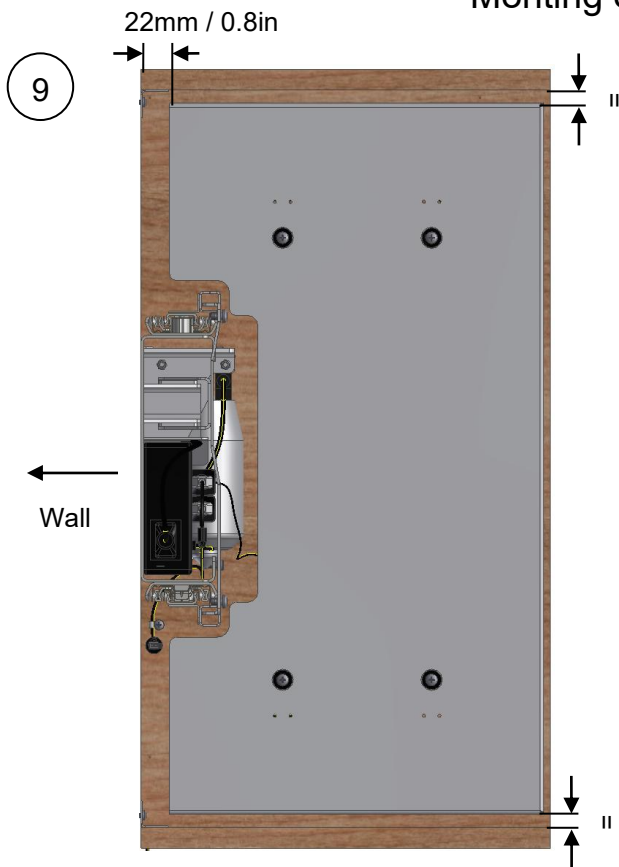

Mount upper safety stop on top of the cupboard. (Illustration shows cupboard viewed from below)

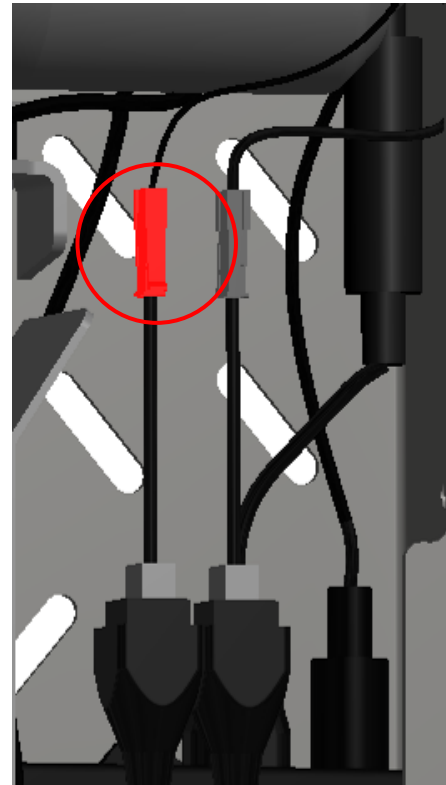

Connect safety stop to control unit, to the cable marked: S1.  
(See wiring diagram page 8)



4 x Ø5x20  
wood screw



4 x 96121409,  
plastic bushing



11

Mount cover plate 30-40400-085

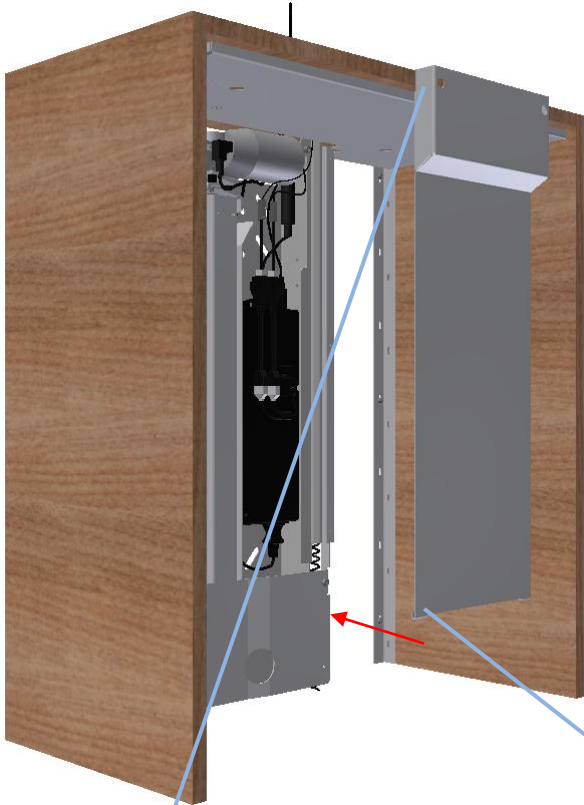

The top of the cover plate has "keyholes" fitting the pre-mounted bolts of the lifting unit

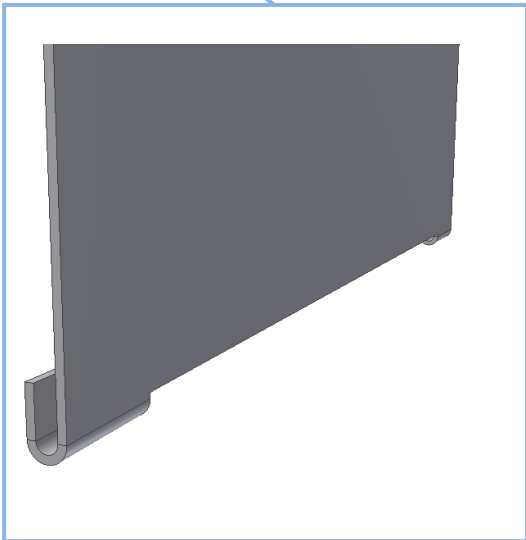

The bottom of the cover plate has a flange fitting around the lifting unit. When the "keyhole" and flange "catch", push the plate upward and tighten the bolts.

12

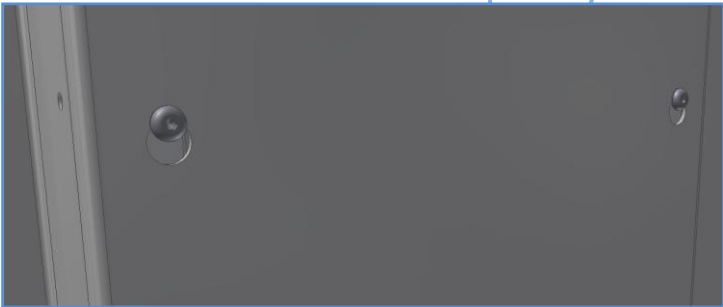

Lift front plate into the cupboard and hook it onto the pre-mounted bolts of the lifting unit. Now mount the remaining 6 bolts

6 x M6x10



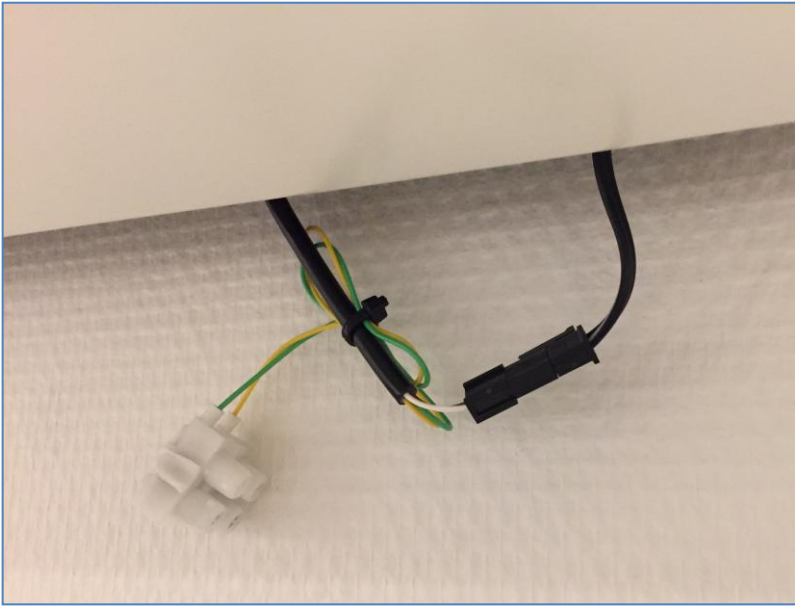

Connect safety stop and spiral cable



13

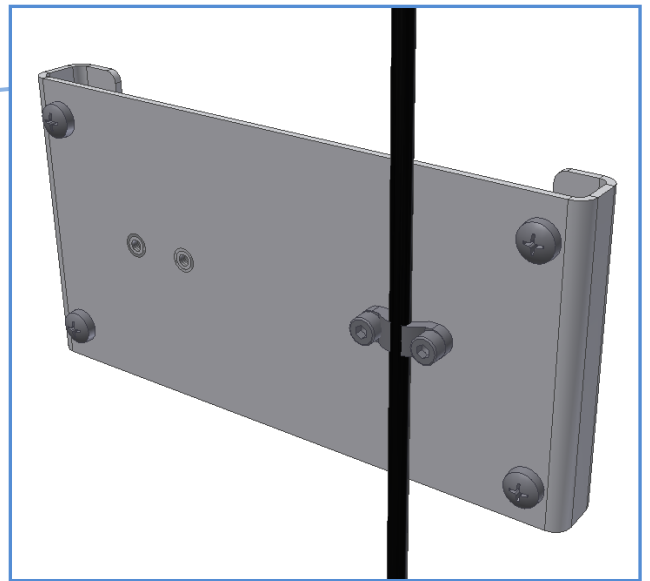
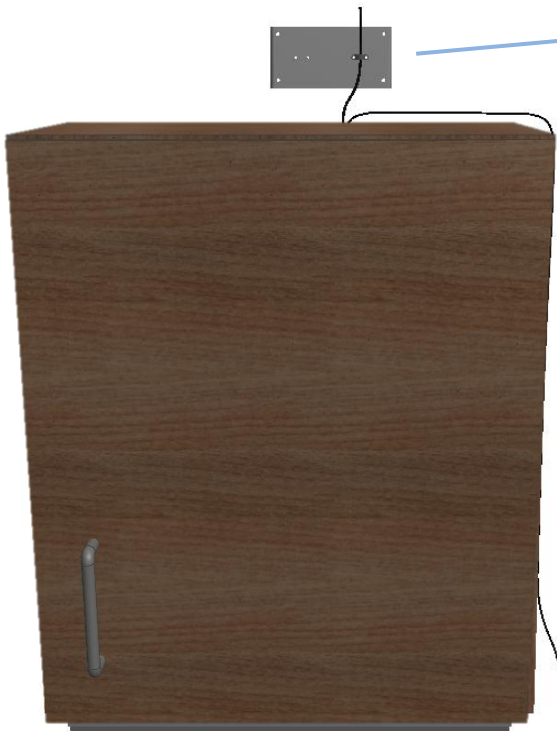

Mount cable relief for mains cable on wall



Place control switch acc. to customer's wish and connect by means of cable: 97000245. If required, use extension cord: 93000162

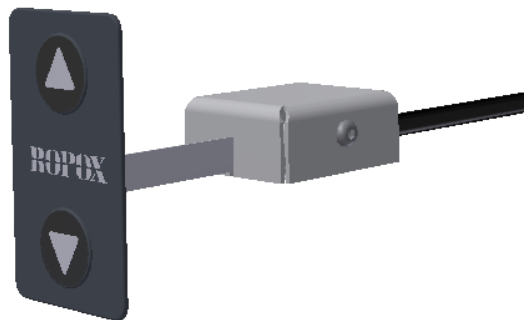
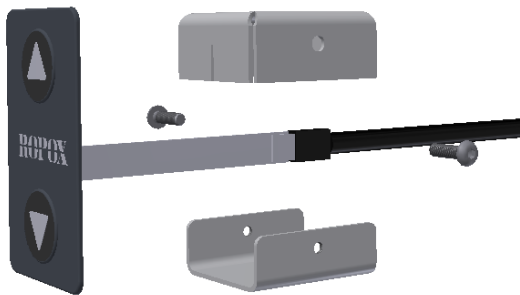

Mount 97701-841 and 97701-842 shielding for control switch

2 x M3x8



## **6.1 Mounting of accessories**

### *6.1.1 Mounting the Bluetooth Adapter for Ropox Connect App*



6.1.1.1 Determine the placement of the adapter, then grab the Bluetooth adapter and the split-cable



6.1.1.2 Insert the split-cable in the plug "HS" in the control box. Then, insert the adapter in one end of the split cable, and the button that came with the product, in the other

6.1.1.3 If the adapter is to be fixed, it should be done now

### *6.1.2 Downloading the Ropox Connect App*

As an option to operate certain Ropox products, it's possible to download the free Ropox Connect App, which makes it possible to operate the product wirelessly. The Ropox Connect App allows you to operate the product upwards or downwards and has the option of saving height settings, allowing users to easily change from a standing height to a sitting height. To see an expanded explanation of functions, accessibility settings, and more, see the enclosed manual, TF 200.0054.

To download the Ropox Connect App, follow the instructions below:

#### **How to download the Ropox Connect App**

##### **For iOS**

1. Scan the QR code or open the app: App Store.
2. In the App Store, press 'Search'.
3. Search for "Ropox Connect".
4. Find the Ropox Connect App, and press 'Get'.



## 7. Performance test

After completed installation and before use all functions of the module must be tested. After that a performance test must be carried out at least once a year by competent personnel.

1. Check that the mounting instructions have been observed.
2. Check that all bolts and screws have been tightened.
3. Check that all cables have been correctly connected and that the plugs have been pressed all the way in
4. There must be no load on the unit.
5. There must be no objects preventing the frame from moving freely within the range of height adjustment.

### Start-up procedure

1. Connect the net cable and turn on the power
2. Connect the motor cables to M1
3. Connect the control switch to HS
4. Press UP on the control switch, move the frame to top position, check that the movement is even and smooth. The frame is now reset.
5. Press DOWN on the control switch, move the frame to bottom position and check that the movement is even and smooth.

### The safety stops must be tested:







**Lower safety stop:** Press the DOWN button and let the cupboard move 2-5cm/0.8-1.9in downwards and activate the safety stop. The unit must now stop the downward movement, move 1-2cm/0.4-0.8in upward and stop.

**Upper safety stop:** Press the UP button and let the cupboard move 2-5cm/0.8-1.9in upwards and activate the safety stop. The unit must now stop the upward movement, move 1-2cm/0.4-0.8in downwards and stop.

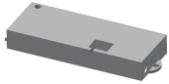
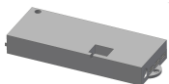
When all these tests have been carried out successfully, the unit is ready for use.

See "Safety in use" Section 11.

## 8. List of components, Verti-Inside

Item number	Designation	Number	Illustration
30-40400-453	Verti-InsideElectric Lifting unit	1 (one)	
30-40400-019	Suspension fixture	1 (one)	
30-40601-144	Relief for mains cable	1 (one)	
96000169	Cable clips 24mm/1in	1 (one)	
95010416	M4x16 bolt, cylindrical head	2 (two)	
30-40440-2	230V Control box	1 (one)	
30-40441-3	120V Control box	1 (one)	
30-40400-085	Cover plate	1 (one)	
	Mains cable 300cm/118.1in	1 (one)	
30-67840	Control switch standard, (3x6 cm) 1 (one) incl. 150cm/59in cable	1 (one)	
93000162	Extension cord for control switch 3.5m/137.8in		
98002087	Spiral cable male/female	1 (one)	
30-40400-113 (40cm) 30-40400-114 (50cm) 30-40400-352 (60cm) 30-40400-462 (60cm) Gray 30-40400-403 (70cm) 30-40400-405 (80cm) 30-40400-407 (90cm) 30-40400-472 (90cm) Gray 30-40400-409 (100cm) 30-40400-477 (100cm) Gray	Front plate	1 (one)	
30-40204-3 (40cm) 30-40205-3 (50cm) 30-40206-3 (60cm) 30-40207-3 (70cm)	Safety stop bottom, for 26.5cm/10.4in cupboard	1 (one)	

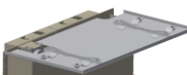
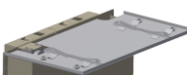
30-40208-3 (80cm) 30-40209-3 (90cm) 30-40210-3 (100cm)			
30-40214-3 (40cm) 30-40215-3 (50cm) 30-40216-3 (60cm) 30-40216-0 (60cm) Gray 30-40217-3 (70cm) 30-40218-3 (80cm) 30-40219-3 (90cm) 30-40219-0 (90cm) Gray 30-40220-3 (100cm) 30-40220-0 (100cm) Gray	Safety stop bottom, for 31cm/12.2in cupboard	1 (one)	
30-40304-1 (40cm) 30-40305-1 (50cm) 30-40306-1 (60cm) 30-40307-1 (70cm) 30-40308-1 (80cm) 30-40309-1 (90cm) 30-40310-1 (100cm)	Safety stop top, for 26.5cm/10.4in cupboard	1 (one)	
30-40314-1 (40cm) 30-40315-1 (50cm) 30-40316-1 (60cm) 30-40316-0 (60cm) Gray 30-40317-1 (70cm) 30-40318-1 (80cm) 30-40319-1 (90cm) 30-40319-0 (90cm) Gray 30-40320-1 (100cm) 30-40320-0 (100cm) Gray	Safety stop top, for 31cm/12.2in cupboard	1 (one)	
95122516	Chip board screw 3.5x16	14 (fourteen)	
95010008	M6x10 bolt, button head	8 (eight)	
95020616	M6x16 countersunk bolt	4 (four)	
96121409	Sleeve bushing	4 (four)	
30-40601-097	Distance washer	4 (four)	
97701-841	Shielding for control switch part 1	1 (one)	
97701-842	Shielding for control switch part 2	1 (one)	

## 9. Options, Verti-Inside

### **Split cable for control switch 96000629:**

To be used if more than one control switch is required

1 (one)



### **Control switch, large press pad (14x7 cm) 30-67841:**

Disabled press pad incl. 150 cm/59in cable

1 (one)



### **Control switch 40-14701-9:**

Control switch with spiral cable

1 (one)

### **Smartbox 30-69002-1:**

Option for safety stop plate

To be ordered if Diagonal is mounted above a FlexiElectric

1 pc.



### **Ropox connect app 30-90591:**

Remote control with app

1 pc.



**LED lighting for kitchen cabinets.**

30-42620-1

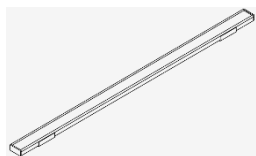

Safety stop plate L=40-50cm  
LED strip L=320mm

30-42621-1



Safety stop plate L=60-70cm  
LED strip L=520mm

30-42622-1



Safety stop plate L=80-100cm  
LED strip L=720mm

30-42623-1



Safety stop plate L=110-120cm  
LED strip L=1020mm

30-42624-1

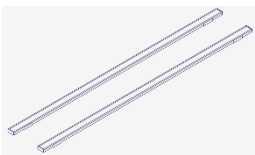

Safety stop plate L=130-140cm  
LED strips 2 pcs. L=520mm

30-42625-1

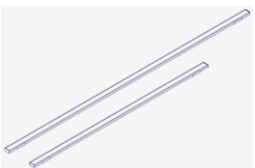

Safety stop plate L=150cm  
LED strips L=520mm & L=720mm

30-42626-1

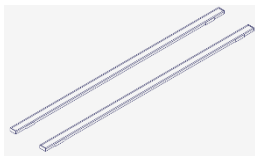

Safety stop plate L=160-180cm  
LED strips 2 pcs. L=720mm

**Included is:**

- Power supply
- Controller
- Remote
- Mounting hardware



## 10. Placing of LED strips.

### For Verti-Inside depth 26,5cm

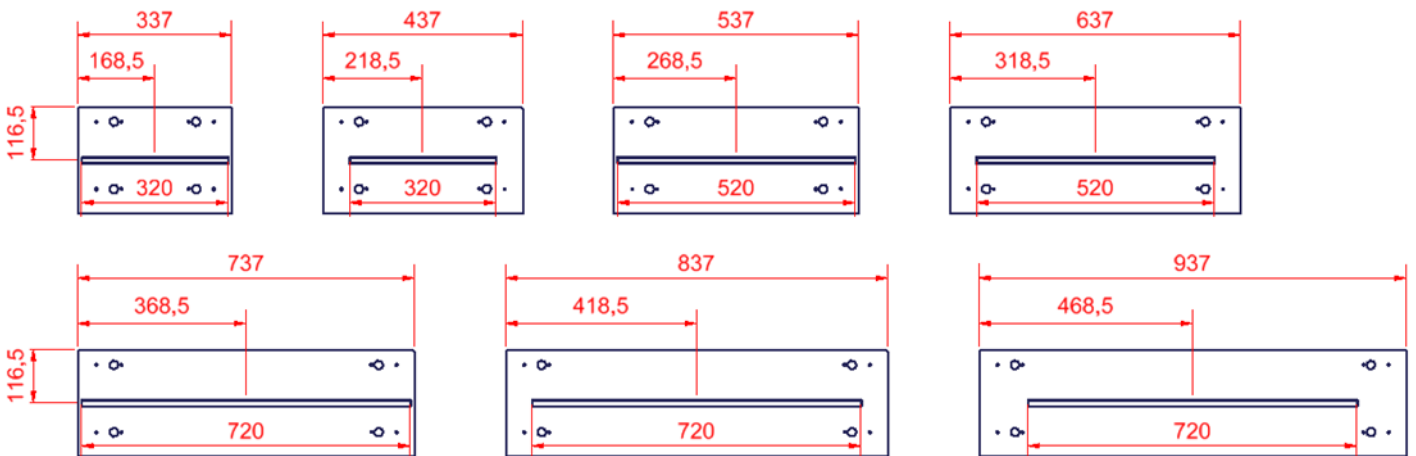

### For Verti-Inside depth 31cm

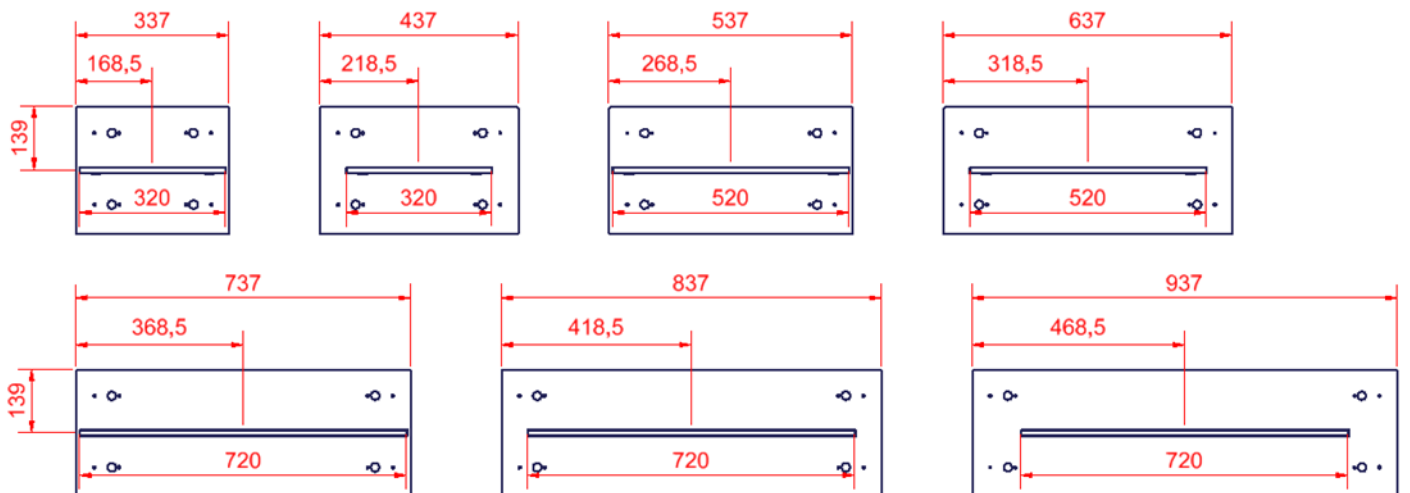

**Accessories:**

Extension strips for mounting on fixed upper cabinets.

Max 3m of LED strips on one Power supply

30-42630-1

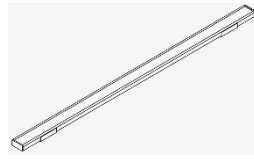

LED strip L=320mm

30-42631-1

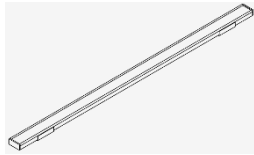

LED strip L=520mm

30-42632-1

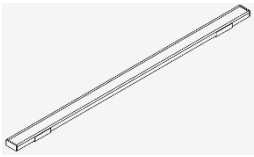

LED strip L=720mm

30-42633-1

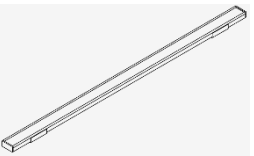

LED strip L=1020mm

**Spare parts:**

30-42627-1



Power Supply

30-42628-1



Controller

30-42629-1



Remote

30-42634-1



Junction box

30-30003-1

Mains cable – UK

30-30005-1

Mains cable – USA

30-30006-1



Mains cable – AU, NZ, China

30-30007-1

Mains cable – Japan

## 11. Cables for LED strips.

Spiral cable male/female is prepared for mounting of light.  
For detailed instructions see the folder that comes with the med LED strips.

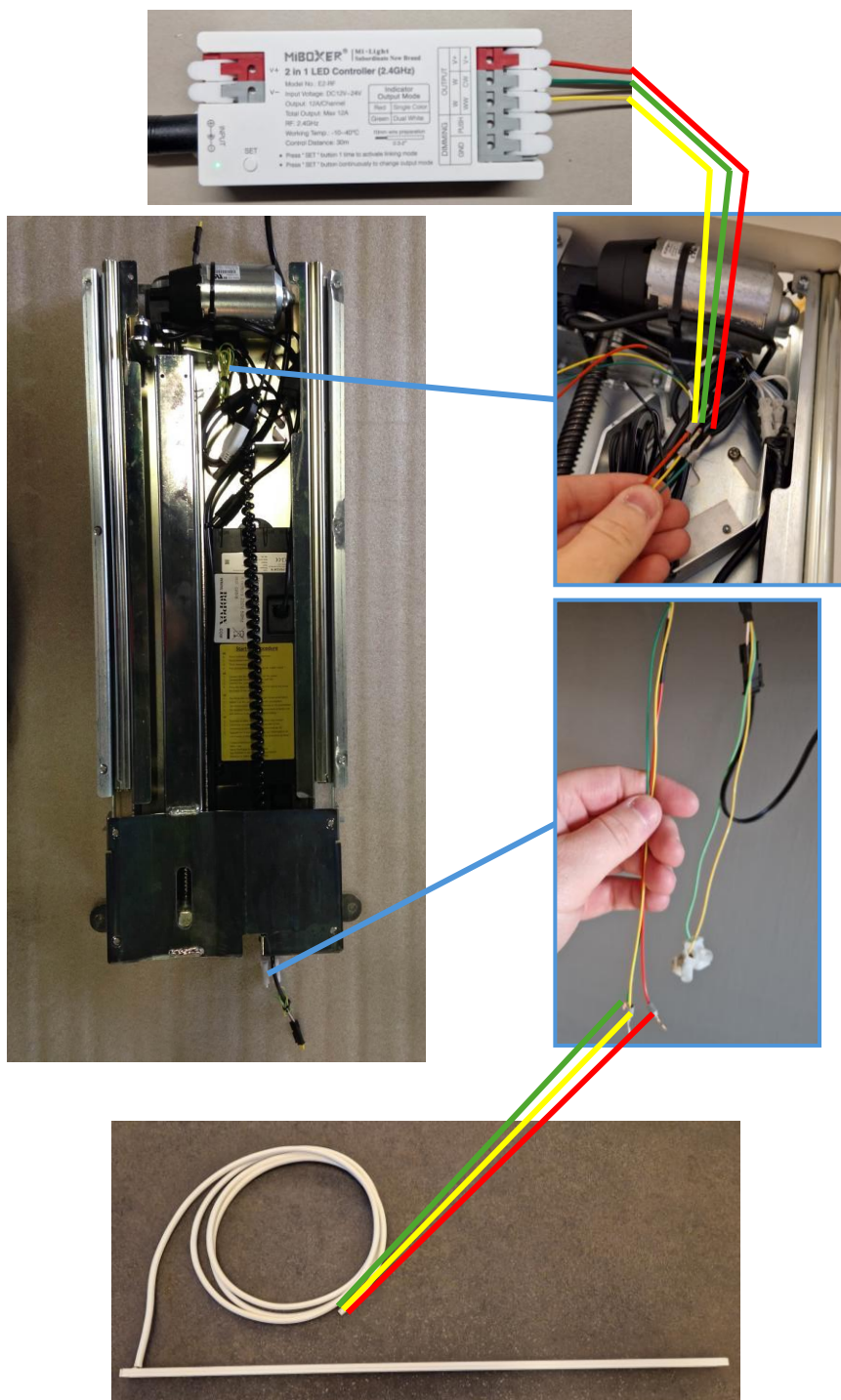

## 12. Safety in use

- Verti-Inside must only be used by persons, who have read and understood these instructions.
- Verti-Inside is an electrically adjustable frame. Even if safety stops have been mounted, it is important to ensure that there are no persons, animals, or objects under the unit during operation.
- Verti-Inside is a cupboard module and must not be used as a lifting unit or person lifter.
- Always use the unit in a manner eliminating the risk of damage to persons or property. The person operating the unit is responsible for avoiding damage or injury.
- Children and persons with reduced observation capacity should only operate the unit when supervised.
- If the product is used in publicly accessible locations where children or persons with reduced observation capacity may get near the unit, the person operating the unit must pay attention to those present in order to prevent dangerous situations.
- Make sure that there is free space above and below the unit to allow height adjustment.
- Do not operate the unit in case of defects or damage.
- Do not overload the unit and make sure that the load distribution is correct.
- Do not use the unit in an explosive environment.
- In connection with inspections, service or repairs always remove loads from the unit.
- Modifications, which may influence the performance or design of the unit, are not allowed.
- Installation, service, and repairs must be carried out by competent personnel.
- If the unit has not been mounted according to these instructions, the right to complain may become void.
- Only use Ropox original spare parts for replacement. If other spare parts are used, the right to complain may become void.

Be careful not to get jammed between shelf and cupboard door during height adjustment with closed cupboard door

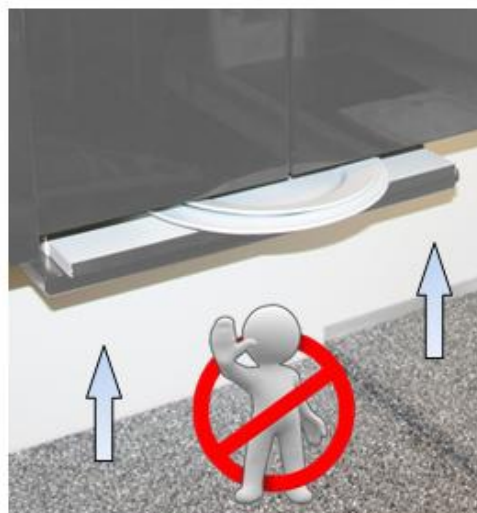

Make sure that the load on the unit is not uneven. The load must be evenly distributed.

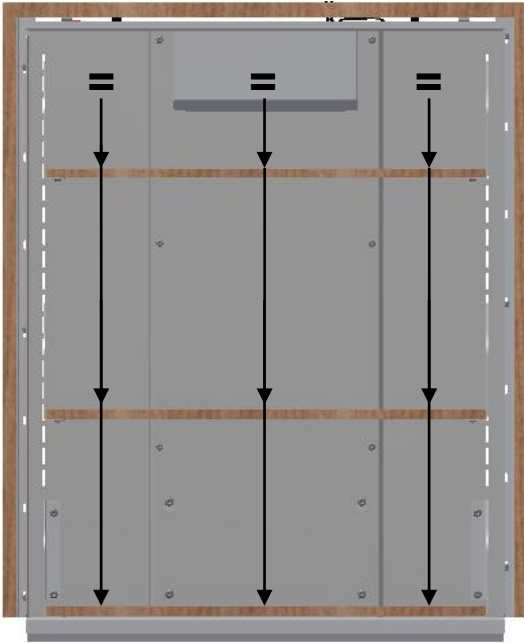

## 13. Cleaning/ maintenance

### 13.1 Cleaning of frame

	<b>WARNING</b> Mains voltage must NOT be connected during cleaning and electrical components must NOT be flushed with water	
---	--	---

Wipe the frame with a wrung cloth with lukewarm water and a mild detergent. Do not use enchansts or abrasives or grinding cloths, brushes or sponges.

After cleaning, dry the frame.

### 13.2 Maintenance

	Inspections, service and repairs must be carried out by competent personnel
---	---

The frame is maintenance free. Moving parts have been lubricated for life. For reasons of safety and reliability, we recommend inspection of the frame once a year:

- Check that all bolts have been securely fastened.
- Check that the frame moves freely and without problems from bottom to top position.
- **Resetting the frame:** Press the UP button and adjust the frame to top position. Press the UP button once more and keep it depressed for 5 sec. to reset the control unit. Check that the movement is smooth and even. Make sure that the mains cable moves freely.
- Check that all cables have been mounted correctly and are undamaged.

After each inspection, complete the service schedule.

Only use Ropox original spare parts for replacement. If other spare parts are used, the right to complain may become void.

### **13.3 Service schedule, operation and maintenance**

<b>Service and maintenance Serial No.</b>
<b>Date:</b> _____
<b>Signature:</b> _____
<b>Comments:</b> _____
_____
_____

<b>Service and maintenance Serial No.</b>
<b>Date:</b> _____
<b>Signature:</b> _____
<b>Comments:</b> _____
_____
_____

<b>Service and maintenance Serial No.</b>
<b>Date:</b> _____
<b>Signature:</b> _____
<b>Comments:</b> _____
_____
_____

<b>Service and maintenance Serial No.</b>
<b>Date:</b> _____
<b>Signature:</b> _____
<b>Comments:</b> _____
_____
_____

## 14. Fault finding

### **14.1 The frame cannot be adjusted in height (adjustment is very difficult)**

1. Check that mains voltage is connected to the control unit and the current has been switched on.
2. Check cables and plug-in connections between control unit and motors.
3. Check cable and plug-in connections between control unit and control switch.
4. Check that cables for safety stops are connected to control unit and safety stops.
5. Check that safety stops have not been activated.

#### **Reset procedure**

6. If none of the above has helped reset the unit:
  - Remove all weight from Verti-Inside
  - Disconnect motorcables
  - Disconnect mains cable and wait 5 sec
  - Connect mains cable
  - Connect motor cable
  - Move the unit to top position for reset.

## 15. Label

Each unit has a label of its own as illustrated. This label contains important information to be stated in connection with inquiries to the supplier. It also contains information about the power supply to be used.

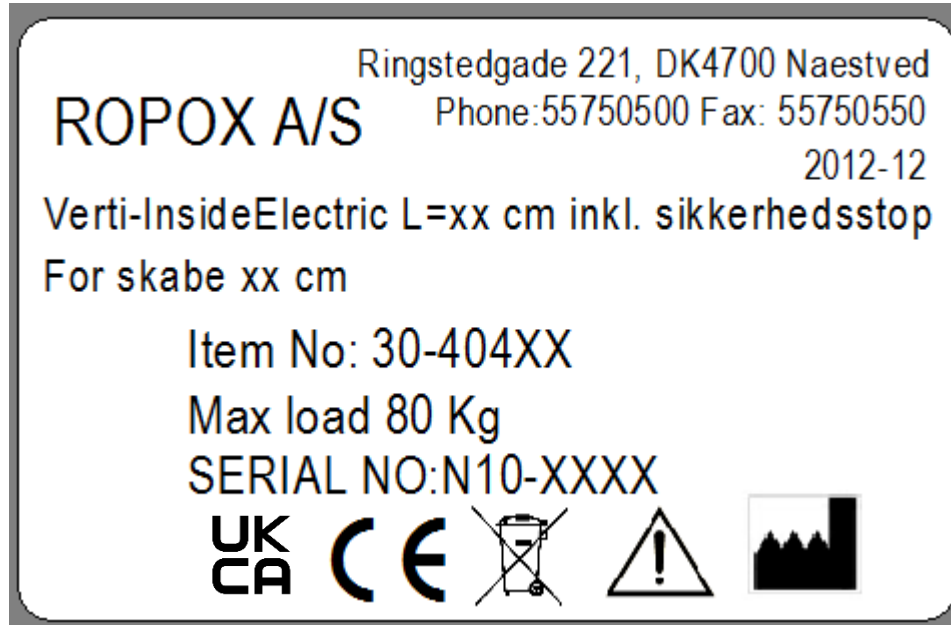

### Symbols:



This manual must be read prior to use.



Waste must be sorted – if possible for recycling.



Ropox is the manufacturer of the product in question.



CE marking. This product meets the requirements for *General Safety and Functionality* of the current EU Directives and Standards.



UKCA marking. This product meets the requirements for *General Safety and Functionality* of the current UK Directives and Standards.



Location of label

## 16. Complaints

See General Terms of Sale and Delivery on [www.ropox.dk](http://www.ropox.dk)

**Keep this folder with the product at all times!**

